

## 17 Warranty

Item number	<b>EP-720</b>		
※ Warranty Period	1 Year from Date of purchase Year _____ Month _____ Day _____ Warranty does not cover blades (upper and lower) and disposables		
Customer	Full name		
	Address	□□□□-□□□□	
		Phone number	- -
Dealer's name, address, phone number, etc. ※			

Note to dealer \*Be sure to fill in this box before giving to customer.

2024.3

### Serial number

Attach your receipt here and keep it in a safe place.

# ARSCORPORATION

www.ars-edge.co.jp/

# ARS



**Cut Above the Rest**



## Cordless rechargeable pruning shears EP-720

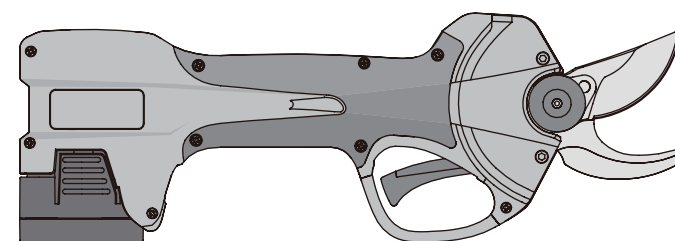

### Table of Contents

1 Name of each part	1
2 Safety precautions	2~5
3 Product features	6
4 How to Use - Charging Instructions	7
How to use - check operation	8~11
5 Pre-work preparation and inspection	12
6 Inspection and maintenance	13
7 Maintenance instructions	14
8 Instructions for use (How to change the blade)	15~16
9 Storage methods	17
10 Error code on the LCD display	18
11 FAQ	19
12 Basic specification	20
13 Maintenance/customer contact	20
14 Optional Accessories	21
15 Free Repair Policy	21
16 Warranty	22

### Handling instructions

with a certificate of guarantee

Thank you very much for your purchase. Please read the instruction manual before use and use the product correctly. After reading the manual, please keep it in a safe place and read it whenever necessary.

Be sure to receive the warranty card from the dealer, making sure that the "date of purchase, name of dealer" etc. are filled in.

# 1 Name of each part

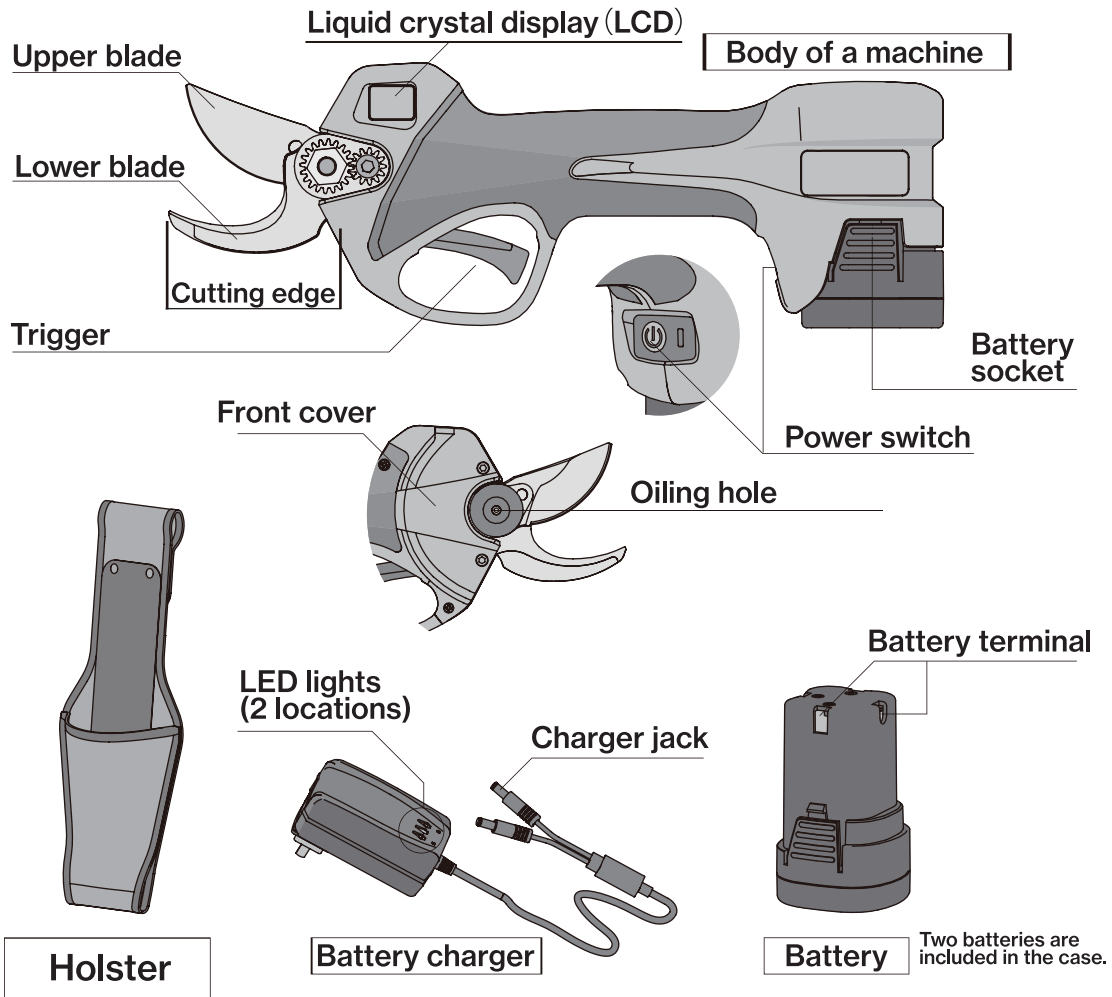

## List of contents

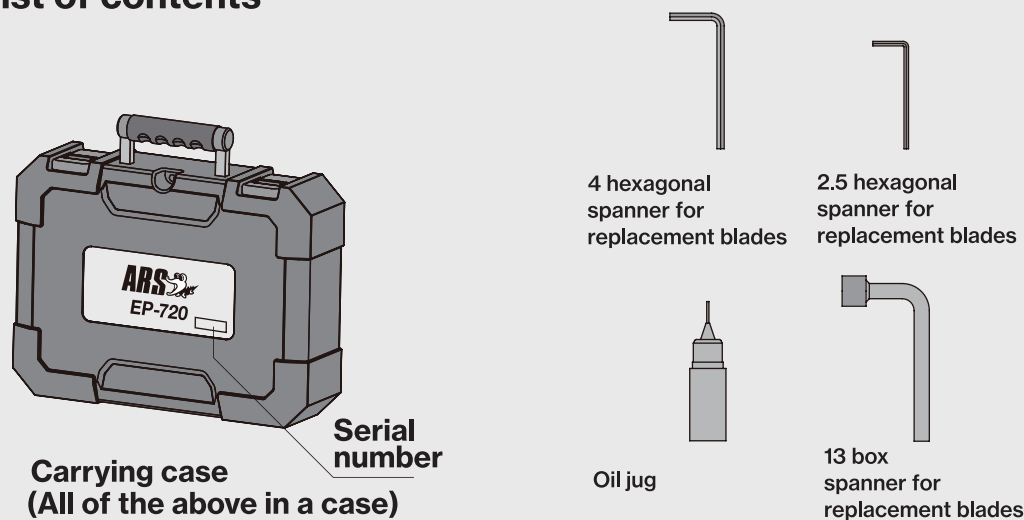

The oil jug does not contain any contents. Use with commercially available lubricant (machine oil).

# 2 Safety precautions

- ★ Before using the product, please read these "Safety Precautions" carefully and ensure correct product usage.
- ★ These precautions are intended to prevent yourself and other persons from injury or loss of properties by safe and proper use of the product. These precautions are differently assorted as severity of risks to "Warning" and "Caution", which can be caused by improper use against these instructions. Please observe these important instructions for safety.

- ⚠ **Warning** : Potential risk of death or serious injury to persons.
- ⚠ **Caution** : Potential risk of injury to persons and damage of property.

## Examples of pictorial displays

- ⊘ : ⊘ This sign indicates that the described behavior is not allowed.
- ⤴ : ⚡ This sign indicates what behavior to be obeyed. For instance, the left sign directs unplugging.

★ After reading this instruction, be sure to keep it in a place where users can find it at any time.

⚠ Warning		
Displays	Notes	Harm/damage
⊘ No contact	● Do not touch the blade with the battery installed.	Casual accident or injury due to unintendedly activated.
⊘ Do not get wet	● Not leaving them outdoors on rainy days. ● Do not use when wet. ● Keep the unit dry. Do not use in damp or wet areas Do not immerse in or splash water Do not use with wet hands.	Risk of electric shock due to electrical leakage.
⤴ Remove the battery	● Always remove the battery when not in use or when replacing the blade.	Casual accident or injury due to unintendedly activated.
! Please observe	● Inspect the product carefully before use. ● Secure no obstructions around you before use.	Risk of accident or injury.
	● Keep people and objects away from the blade during operation. ● Switch off and discontinue use if unusual noises, heat generation or abnormal operation is detected during use.	Injury or loss of property caused by contact with blades Possible malfunction, risk of fire, electric shock or injury.





## 2 Safety precautions

⚠ Warning		
Displays	Notes	Harm/damage
 Prohibition	<ul style="list-style-type: none"> <li>Do not use other batteries than originally packed.</li> <li>Do not use for other purposes than pruning.</li> </ul>	Risk of malfunction which may cause fire, electric shock, and injury.
	<ul style="list-style-type: none"> <li>Do not cut branches in larger diameter than specified.</li> </ul>	Risk of malfunction and injury.
	<ul style="list-style-type: none"> <li>Do not leave in hot places.</li> </ul>	Risk of malfunction which may cause fire, electric shock, and injury.
	<ul style="list-style-type: none"> <li>Do not store in places generating condensation by big change of temperature.</li> </ul>	
	<ul style="list-style-type: none"> <li>Do not disassemble, repair, or modify the product, which are not covered by this instruction, if you are not such a specialist.</li> </ul>	Causing you topple or fall with injury or damage of property.
	<ul style="list-style-type: none"> <li>Do not use close to flammable liquids or gases.</li> </ul>	Explosion or fire hazard.
	<ul style="list-style-type: none"> <li>Do not use in condition or place of unstable footing.</li> </ul>	Causing you topple or fall with injury or damage of property.
	<ul style="list-style-type: none"> <li>Do not be used by or placed closed to a child or an infant.</li> </ul>	Injury or loss of property caused by contact with blades.
	<ul style="list-style-type: none"> <li>Do not use in high places like on roof or ladders.</li> </ul>	Causing you topple or fall with injury or damage of property.
	<ul style="list-style-type: none"> <li>Do not use the product if you are in fatigue, drunk, any concerns about health.</li> </ul>	Risk of accident or injury.

⚠ Caution		
Displays	Notes	Harm/damage
 Please observe	<ul style="list-style-type: none"> <li>Wear suitable clothing for pruning works. Long-sleeved and long trouser fitting your body. Gloves Protective glasses</li> <li>Please replace a broken blade with new one immediately.</li> </ul>	Risk of accident or injury.

## 2 Safety precautions

### Safety precautions regarding batteries

⚠ Warning		
Displays	Notes	Harm/damage
 Do not get wet	<ul style="list-style-type: none"> <li>Do not get the battery/charger wet. Do not use in humid or wet environment. Do not expose to water or splash. Do not use with wet hands.</li> </ul>	Risk of malfunction which may cause fire, electric shock, and injury.
 No contact	<ul style="list-style-type: none"> <li>In the event of battery fluid leakage, stop using immediately and do not contact the leaked battery fluid.</li> </ul>	Risk of ignition, which may cause fire or injury.
	<ul style="list-style-type: none"> <li>Leaked battery fluid is extremely dangerous and should be kept away from inflammable environment.</li> <li>If battery fluid comes into contact with your eyes or skin, promptly wash with clear water and seek immediate professional medical advice.</li> </ul>	Risk of injury
 Remove the battery	<ul style="list-style-type: none"> <li>Remove the battery from the main body while not in use.</li> </ul>	Risk of electric shock and fire.
	<ul style="list-style-type: none"> <li>Unplug the charger from the power outlet while not in use.</li> </ul>	
 Please observe	<ul style="list-style-type: none"> <li>Charge the battery indoors.</li> </ul>	Risk of explosion and fire.
	<ul style="list-style-type: none"> <li>Do not charge battery with ambient temperature below 5°C or above 45°C. In particular, avoid charging in cold environment.</li> </ul>	
	<ul style="list-style-type: none"> <li>If the charger or battery becomes abnormally hot during charging, immediately remove the power plug and stop charging.</li> </ul>	
 Prohibition	<ul style="list-style-type: none"> <li>Follow local authorities' instructions when disposing of batteries.</li> </ul>	
	<ul style="list-style-type: none"> <li>Do not charge, use or leave the battery near fire or in hot or imperial locations such as in the direct sunlight.</li> </ul>	Risk of battery degradation, explosion and fire.
	<ul style="list-style-type: none"> <li>Do not charge in the presence of lacquer, paint, benzene, thinner, petrol, flammable gases, adhesives, etc.</li> </ul>	Risk of explosion and fire.
	<ul style="list-style-type: none"> <li>Do not give a physical shock to the battery, disassemble, modify nor crush the battery.</li> </ul>	
	<ul style="list-style-type: none"> <li>Do not use battery that has been dropped, got a physically impacted, damaged or deformed.</li> </ul>	

## 2 Safety precautions

### Safety precautions regarding batteries

⚠ Warning		
Displays	Notes	Harm/damage
 Prohibition	<ul style="list-style-type: none"> <li>● Please use the charger under the power supply specified in the rating. Also, do not charge the battery with the following equipment: step-up transformers, DC power supplies, car lighter cigarette socket power supplies, engine generators, and portable power supplies.</li> </ul>	Risk of malfunction which may cause fire, electric shock, and injury.
	<ul style="list-style-type: none"> <li>● Do not cover the battery with anything that may accumulate heat while charging.</li> <li>● Do not charge batteries other than ours with the supplied charger. Also, do not charge the supplied battery with a charger other than ours.</li> </ul>	
	<ul style="list-style-type: none"> <li>● Do not charge in the presence of infants or pets.</li> </ul>	Risk of overheating, ignition, or rupture which may cause fire, electric shock, and injury.
	<ul style="list-style-type: none"> <li>● Do not put the battery into a fire or heat it.</li> </ul>	
	<ul style="list-style-type: none"> <li>● Do not allow metal or other objects to contact with the battery terminals.</li> </ul>	
	<ul style="list-style-type: none"> <li>● Do not expose the battery to electromagnetic radiation or high voltage.</li> </ul>	

⚠ Caution		
Displays	Notes	Harm/damage
 Please observe	<ul style="list-style-type: none"> <li>● Do not recharge a fully charged battery just after a few minutes of usage.</li> </ul>	Risk of battery degradation.
	<ul style="list-style-type: none"> <li>● If you do not use the battery for a long period, fully charge the battery before storing it. Also, charge the battery once every three months.</li> </ul>	If left undercharged for a long time period of time, the battery may deteriorate and malfunction.
	<ul style="list-style-type: none"> <li>● New batteries or batteries that have not been used for a long time may be dormant. To release from dormant, it will be necessary to repeat charging and discharging several times. *New batteries or batteries that have not been used for a long time Batteries may be dormant. The battery may be dormant.</li> </ul>	Dormant batteries may run out of charge quickly even after a full charge.

## 3 Product features

Founded 140 years ago, we have leveraged our expertise as a horticultural blade manufacturer to develop specialized blades for electric pruning shears that excel in durability while minimizing branch slippage. Our cordless and electric design reduces the burden on workers while delivering comfortable cutting performance.



Please refer to the official website for various videos and more detailed information.

### Cordless for easy handling!

Being rechargeable and cord-free allows for pruning in any position you desire.

### Reduce the burden of regular work with electric operation.

Simply pull the trigger to prune. This reduces hand strain during pruning and significantly improves efficiency during the pruning season.

### Blade opening at your fingertips! Targeting intricate branches made easy.

Unlike the simple on/off style with cutting and opening, we employ a responsive mechanism synchronized with the trigger for precise targeting. With the blade opening freely adjustable, even intricate branches become easy targets, allowing for precise pruning as desired.

### Industry-first! "Anti-Slipping Edge Grinding"

Our electric pruning shears feature specialized blades that prevent slipping and enable smooth cutting even with thick branches.

### Even thick branches can be cut off smoothly!

This unique function employs a sharp edge and slightly blunt angle gradient on the lower blade. This special grinding ensures that the blade grips the cutting target, enabling secure cutting even on thick branches.

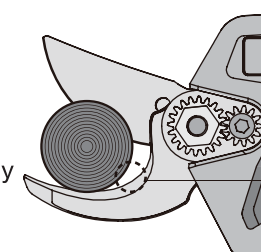

The blade bites firmly into thick branches without slipping.

### With the powerful electric force, our shears stand up to tough cuts with "Enhanced Durability 3-Stage Processing"!

To withstand the strong power of electric pruning shears and minimize blade chipping, we employ a 3-stage processed blade on the upper blade, one stage more than manual pruning shears. This design meets the demands of professional use in the field.

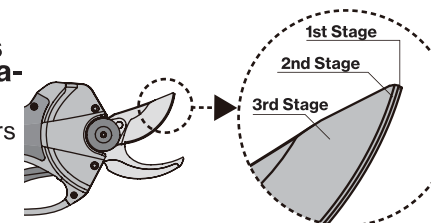

### Trimming 25mm thick branches in 0.3 seconds ※!

Simply pull the trigger to cut through live wood up to a maximum diameter of 25mm in just 0.3 seconds※. This allows for speedy pruning operations.

※ 1 cycle is 0.6 seconds

### Quickly cut small branches with a 2-stage blade opening adjustment function.

When pruning many small branches, you can switch to "small branch mode" with a narrow blade opening width. Since the blade opening width is narrow, the opening and closing speed increases, allowing for rapid repeated cutting.

### Convenient to carry with dedicated holster

### Durable wax-coated carrying case

### Cost-effective replaceable blade design

## 4 How to Use - Charging Instructions

### Charging Instructions

- 1 Connect the battery to the charger.
- 2 Insert the plug of the charger into the wall socket.

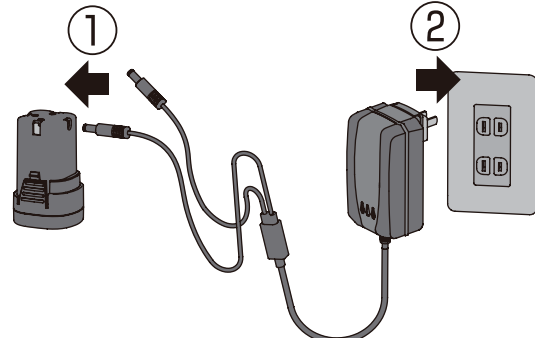

### About the state of the LED lights

#### Two batteries can be connected to the charger

\*When two batteries are connected, they will be charged sequentially, one by one, rather than collectively.

The LED indicator when two batteries are connected.

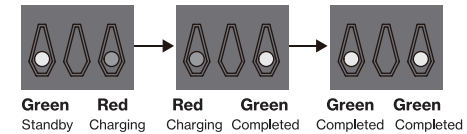
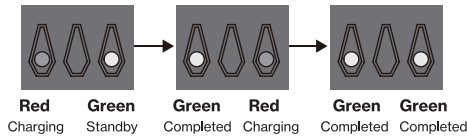

The LED indicator when one battery is connected.

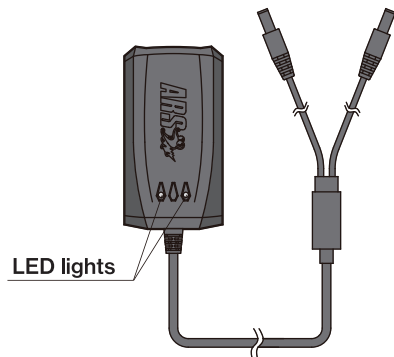
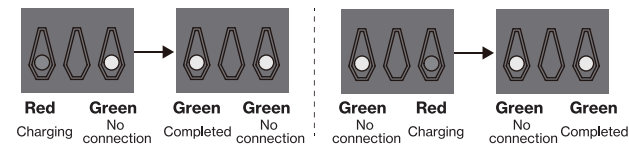

Red light

Charging

Green light

Waiting for charging  
Charging complete, no connection

**Do not remove the battery from the charger until the two LED lights turn green.**

When one LED light is red, the green one is waiting for charging and may not be fully charged.

### ⚠ Caution



Please observe

Always charge batteries indoors.

Charge the battery in an environment between 5°C and 45°C.  
\* Avoid charging in particularly cold environments.

Do not charge the battery near a source of ignition, under high temperature, nor high humidity (e.g., in the hot sun).

### ⚠ Caution



Please observe

A new battery or a battery that has not been used for a long time may be dormant. Dormant batteries may quickly run out of power even when fully charged, so repeat charging and use a few times to eliminate the dormant state before use. \*If the battery does not recover, replace it with a new one.

## 4 How to use - Check Operation

### Preparation before use

**⚠ Caution**

Please observe

Hold the device correctly so that you do not drop it during use.

- 1 Insert the battery into the socket.
- 2 Hold the body firmly and press the power button with your other hand for at least one second". A beep will sound and the green LED and LCD panel will light up.

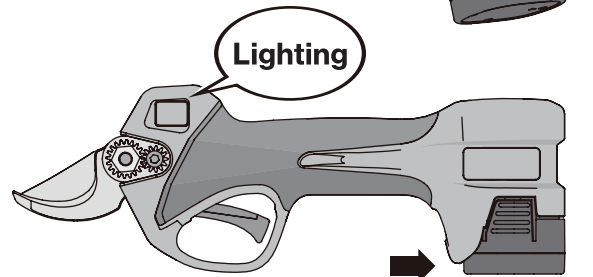
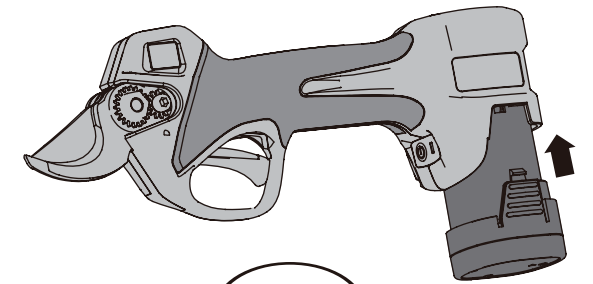

**Ping** ① Press the power button "beep" (at least 1 second).

- 3 After approximately 2 seconds, there will be another beep. At this point the system is ready.

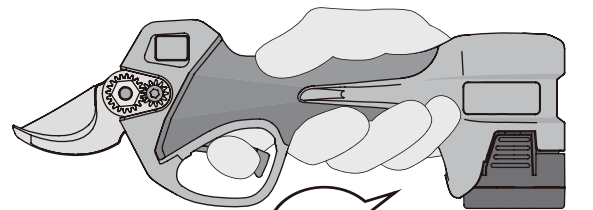

**Beep** ② The buzzer sounded.

- 4 Quickly repeat the "pull and release" action of the trigger two or more times.

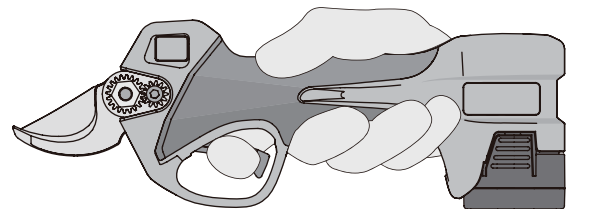

③ Quickly pull and release the trigger at least twice.

- 5 The "beep, beep, beep" buzzer will sound three times and the blade will open. Pull and release the trigger to check that the blade opens and closes securely in accordance with the trigger action, and if there are no problems, begin the trimming operation.

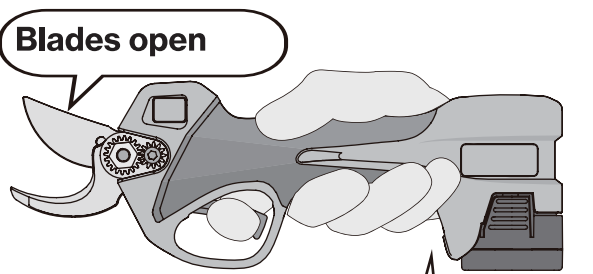

④ Three buzzers sounded.

Beep, beep, beep

## 4 How to use - Check Operation

### How to complete the job

- ① Pull the trigger (closed) and press the power button.
- ② A beep is emitted, the power turns off, and the display on the LCD panel disappears.
- ③ Remove the battery from the socket.
- ④ Stored in a box.

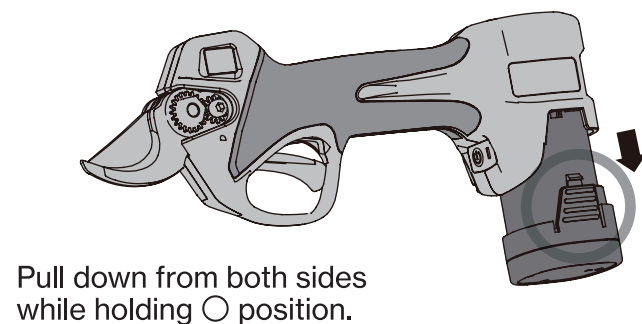
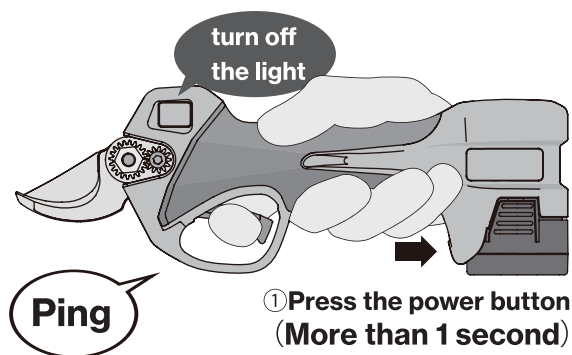

### Other Functions.

#### Adjustment of blade opening width.

Large blade opening - Standard mode.  
Small blade opening - fine branch mode.

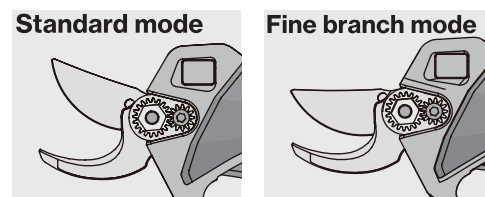

\*If you only cut thin branches for pruning work, use blades with narrower openings (thin branch mode). Narrowing the blade opening saves power and speeds up opening and closing repetitions.

#### Fine Branch Mode

- ① Continue to pull the trigger (closed). After about 3 seconds, a beep will sound, so release the trigger immediately.

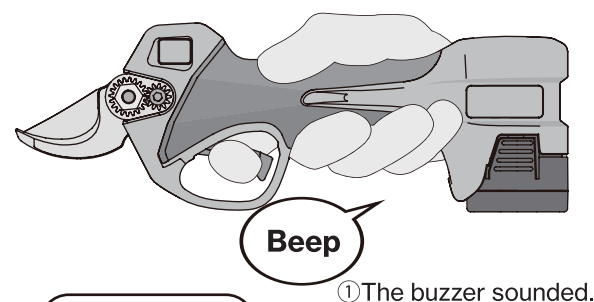

- ② The blades open narrowly. This opening width remains constant until the power is turned off or returned to the initial position (reset).

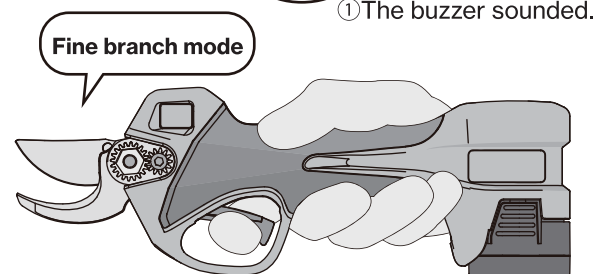

## 4 How to use - Check Operation

### Returns the blades opening width to standard mode. (Reset)

- ① Pull the trigger (closed). After approximately 3 seconds, you will hear two beeps and then immediately release the trigger. The blades will open in standard mode.

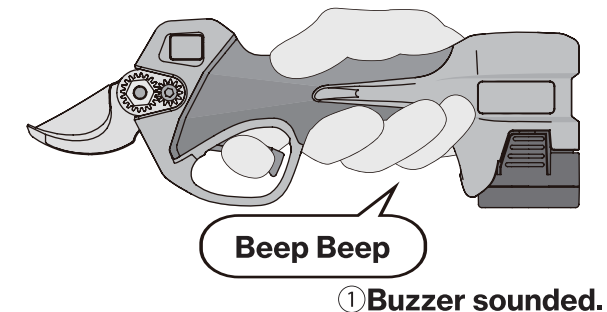

\*Regardless of the state in which the unit was turned on before the power was turned off, it will revert to the standard mode when it is turned back on after the power is turned off.

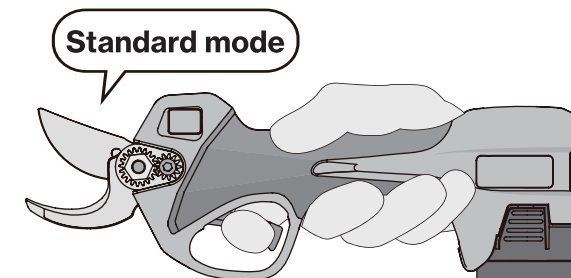

### Putting the user into sleep mode

\*If you want to return to work immediately without turning off the main power, use the following operation to put the device in sleep mode.

- ① Pull the trigger (closed). After about 3 seconds, a beep will sound.

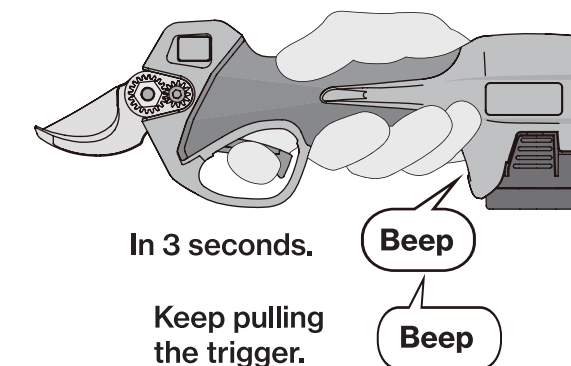

- ② If you continue to pull the trigger, the "beep" will sound again and the unit will enter sleep mode. It will remain closed when the trigger is released.



## 4 How to use - Check Operation

### Recovering from Sleep Mode

① Repeat the "pull and release" action of the trigger two or more times quickly.

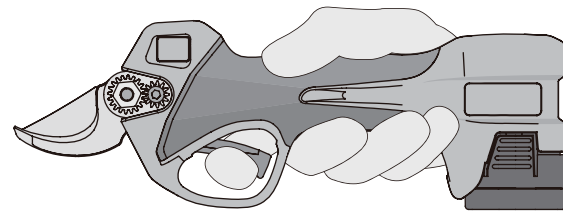

① Quickly pull and release the trigger at least twice.

② "Beep-beep-beep," the buzzer sounded three times and the blades opened.

Pull and release the trigger to check that the blades open and closes securely in response to the movement of the trigger, and if there are no problems, begin the trimming operation.

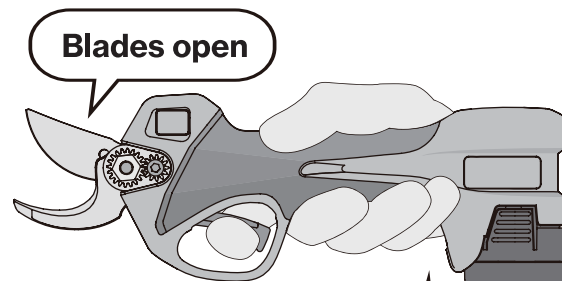

④ Buzzer sounds three times. Beep-beep-beep

### Autosleep

① After 3 minutes of no triggering operation with power on, a beep will sound and the unit will automatically go into sleep mode (with power on and LCD on).

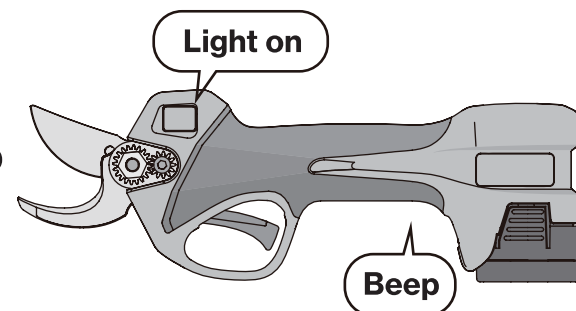

※\*If you enter sleep mode with the blades still open, the buzzer will sound three times when returning from sleep mode and the blades will return to the open position.

### Automatic power off

① If it does not re-enter auto-sleep mode after another 7 minutes, a beep will sound and the power will automatically turn off. The LCD display will also turn off.

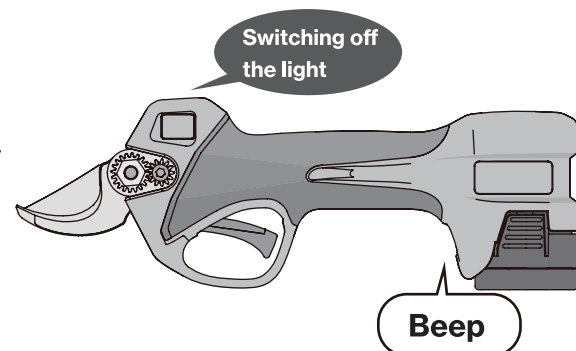

### ⚠ Caution



Please observe

If you turn off the power while the blades are open, turn on the power, close the blade, and then turn off the power, as the blade may cause injury.

## 5 Pre-work preparation and inspection

### Preparation before use

#### 1. Wear safe and comfortable work clothing

- Wear long sleeves, long trousers, gloves and an apron or other item that you don't mind getting dirty.

- Wear protective goggles.

#### 2. Inspect and maintain screws for looseness or detachment before work.

- Inspect the blade for chips, wrinkles and foreign objects.

- Check for any rattling in the blade section.

**How to check** Touch the upper blade to see if it rattles.

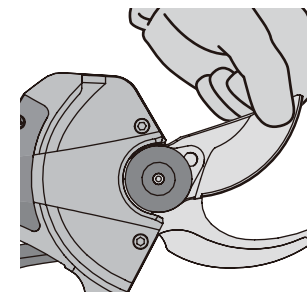
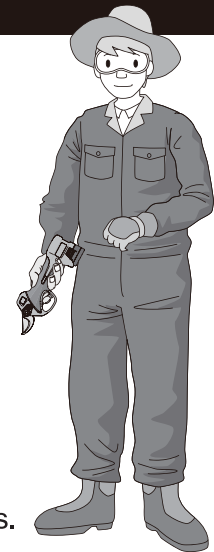

### ⚠ Caution



Please observe

Please make sure to turn off the power, disconnect the battery, and wear gloves, when checking the blade.

### Maintenance method

If there is any rattling, service it according to the following procedure

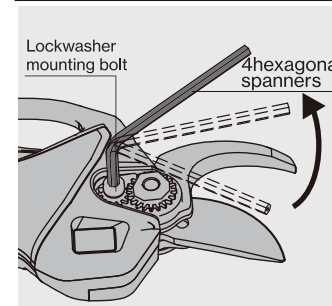

Use a 4 hexagonal spanner for replacement blades to loosen the lockwasher mounting bolt.

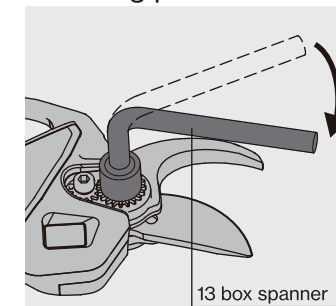

Tighten the center nut with a 13 box spanner for replacement blades.

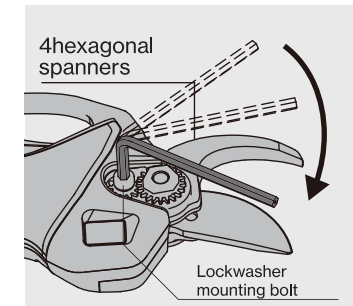

Tighten the lockwasher mounting bolt with a 4 hexagonal spanner for replacement blades.

#### 3. Attach the holster to the belt loop of your pants.

\*We recommend that the wider and thicker the belt, the better.

#### 4. Insert the battery into the battery socket on the body of the scissors.

#### 5. Place the scissors in the holster and move to the area to be trimmed.

## 6 Inspection and maintenance

### Inspection and maintenance

Inspection section	Check points.	How to maintenance	page
Blade part	In case resin or astringent is on the blades.	Remove resin or astringent with a brush etc.	14
	In case there are any loose or missing screws.	Tighten the screws.	12
	In case the blades are worn, chipped, clacked, or deformed.	Replace the blade.	15 16
	In case there is debris (wood chips, leaves, sand, etc.) around the gear plate.	Remove the front cover, remove debris, and wipe clean with a dry cloth.	15 16
	In case the blades are rattling.	Tighten the screws so that there is no rattling.	12
<div style="text-align: center;"><b>⚠ Caution</b></div> <div style="display: flex; align-items: center;"> <p>Please make sure to turn off the power, disconnect the battery, and wear gloves, etc., when checking the blade.</p> </div>			
Batteries	If the battery is charged.	Check the battery level.	7 18
	<div style="text-align: center;"><b>⚠ Caution</b></div> <div style="display: flex; align-items: center;"> <p>A new battery or a battery that has not been used for a long time may be dormant. Dormant batteries may quickly run out of power even when fully charged, so repeat charging and use a few times to eliminate the dormant state before use. *If the battery does not recover, replace it with a new one.</p> </div> <div style="display: flex; align-items: center; margin-top: 5px;"> <p>If the battery is extremely short-lived, replace it with a new one.</p> </div>		
	In case the blades do not work properly even the battery is inserted into the battery socket on the body of the scissors.	Insert the battery back in. *May be poor contact.	8
LCD	In case an error code is displayed on the LCD when turning on the power.	Take action based on the error number.	18

## 7 Maintenance instructions

### How to care for blades

When cleaning, turn off the power with the blade open, disconnect the battery, and wipe off any dirt with a dry cloth.

- ① With the blade open, release your finger from the trigger and press the power button.
- ② A beep is emitted, the power turns off, and the display on the LCD disappears.
- ③ Remove the battery from the socket.
- ④ Clean dirt from the blade.

#### Remove resin or astringent with a brush etc.

Use a brush or other tool to remove resin or astringent from the blades. The blades may feel sluggish when resin or astringent accumulates. Clean the blades frequently to prevent the buildup of resin or astringent, especially in the crevices.

**⚠ Caution**

When cleaning with liquid cleaners such as blade cleaner, do not spray directly.  
If liquid enters the main unit housing, malfunction may occur.

- ⑤ Fill the "oil pot" with commercially available lubricant (machine oil) and lubricate the oil supply port on the blade bolt. If the oil is spilled, wipe it off with a dry cloth.

- ⑥ Insert the battery, turn on the power and close the blade.

**⚠ Caution**

Please make sure to turn off the power and disconnect the battery before cleaning the blades.

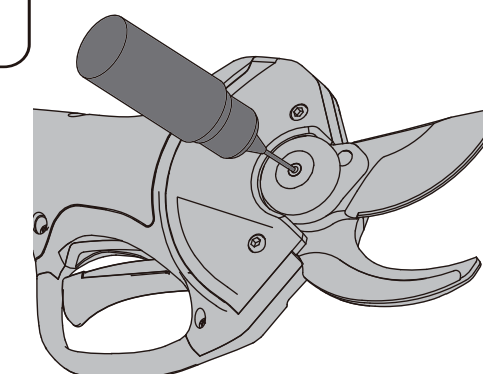
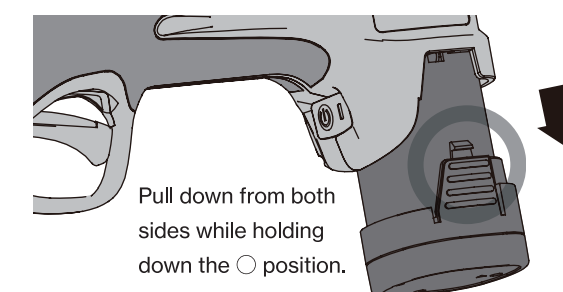
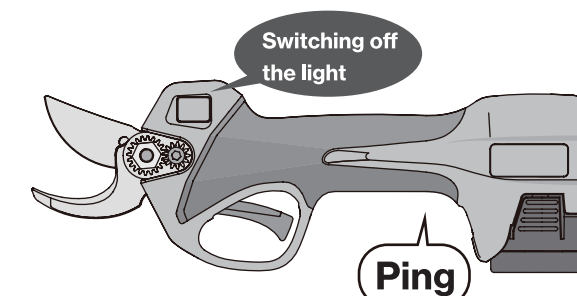



## 8 Instructions for use - How to change the blades

If the upper and lower blades no longer overlap after sharpening, or if you can no longer cut branches cleanly due to chipping or other damage, purchase new blades and follow the steps below to replace the blades.

### What to prepare

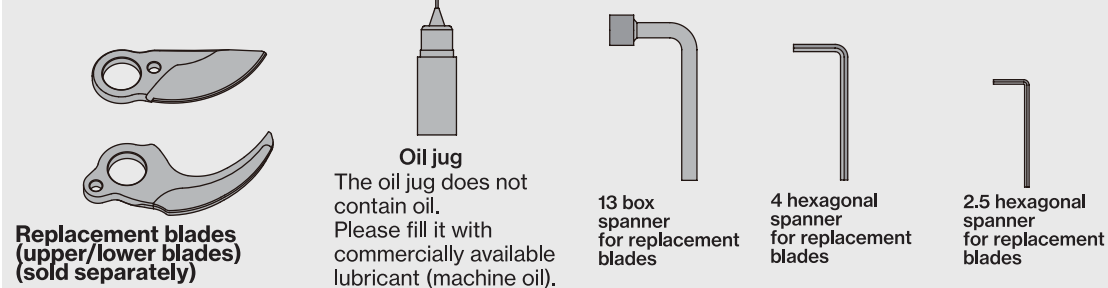

① Turn off and disconnect the battery.

② Follow the steps in the diagram below to replace the blades.

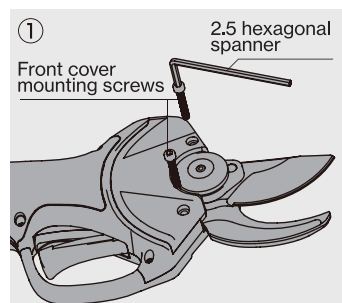

Using the "2.5 hexagonal spanner for replacement blades", remove the front cover mounting screws (2 places) from the front cover of the main unit housing. Be careful not to lose the screws.

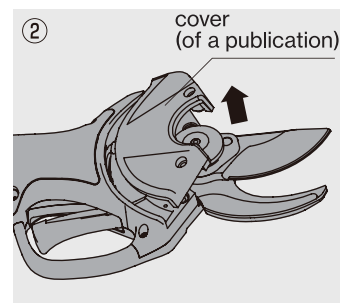

Remove the front cover.

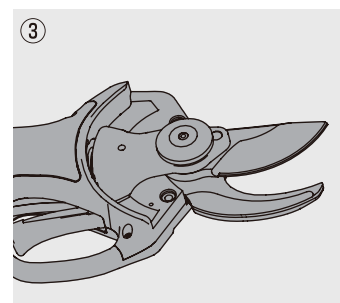

Remove the front cover.

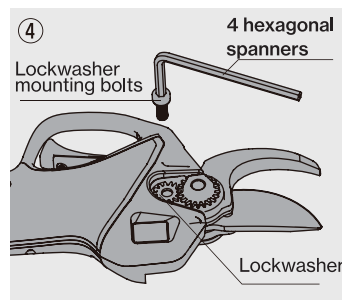

Turn the unit over and remove the lockwasher mounting bolt using the "4 hexagonal spanner for replacement blades" and remove the lockwasher.

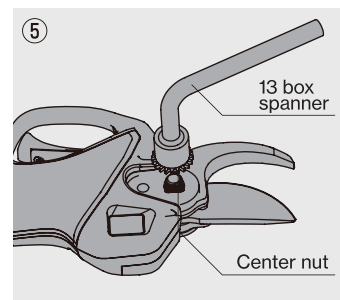

Remove the center nut with the "13 box spanner for replacement blades".

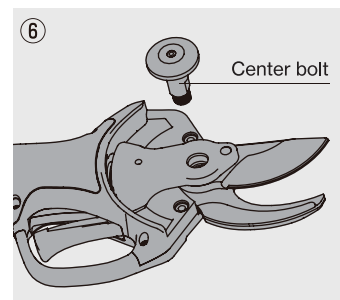

Remove the centre bolt on the other side.

## 8 Instructions for use - How to change the blades

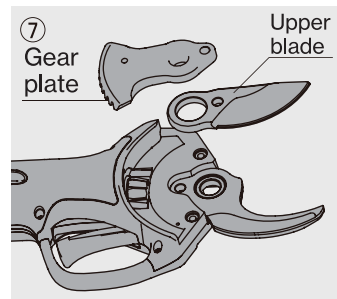

Remove the gear plate and top by hand.

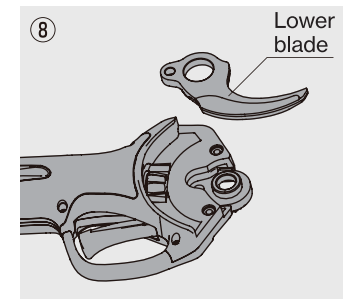

Remove the lower blade.

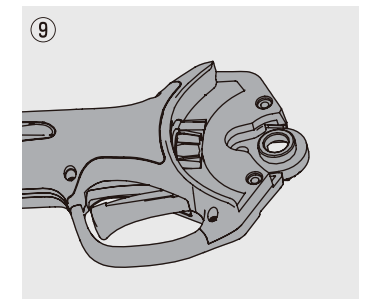

Dismounting complete

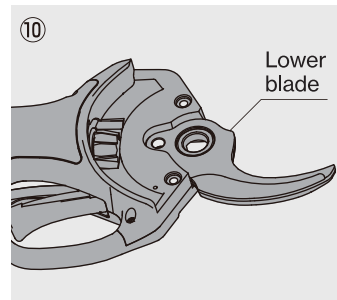

Install the lower blade as shown.

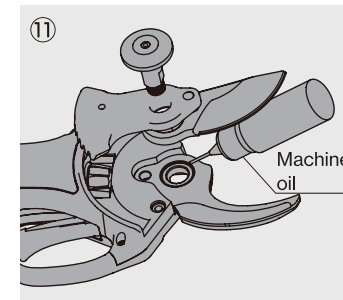

Overlap the upper blade and gear plate and insert the centre bolt. Apply 2-3 drops of machine oil to the sliding parts of the lower and upper blades (where they overlap).

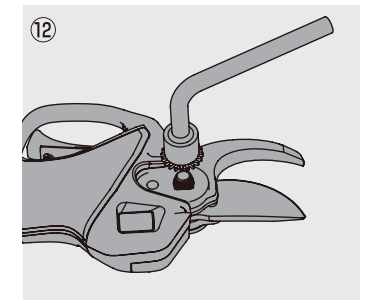

Turn the unit over while supporting the rear bolts by hand to prevent them from falling out, then tighten the center nut with a "13 box spanner for replacement blades".

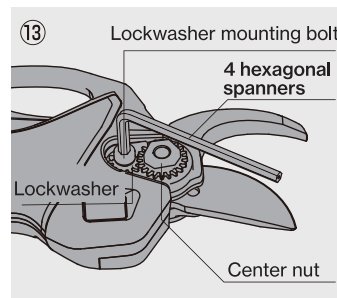

Place the lockwasher and lockwasher mounting bolt in the order shown in the illustration and tighten the lockwasher mounting bolt using the "4 hexagonal spanner for replacement blades" to secure the lockwasher.

If the lockwasher mounting bolt is difficult to insert, loosen the center nut and insert the lockwasher mounting bolt. After inserting the lockwasher mounting bolt, tighten the center nut and lockwasher mounting bolt and secure in place.

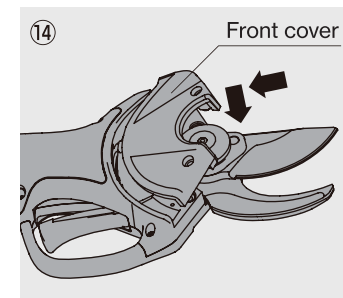

Place the front cover on the main unit housing. (Insert the claw into the main unit first, then push the front cover through).

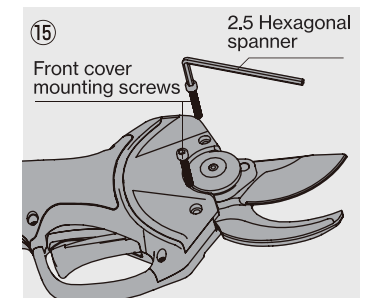

Secure the front cover with the front cover mounting screws (2 places). Tighten using the "2.5 hexagonal spanner for replacement blades".

After replacing the blades, insert the battery into the machine and turn it on to check if the blades are working properly.

## 9 Storage methods

### Storage methods

- When storing the device, turn off the power and please make sure to disconnect the battery from the device.
- Any damaged parts must be repaired or replaced before storage.
- Store in a suitcase in a cool, dry place out of direct sunlight.
- Store in a safe place out of reach of children.

⚠ Precautions when storing batteries and chargers		
	Notes	Harm/damage
 Please observe	Do not store in ambient temperatures above 45°C like in a car.	Battery deterioration, explosion or fire may occur.
	Do not store in a place where the temperature fluctuates and condensation may occur.	
	Do not place flammable materials around the battery.	There is a risk of overheating, ignition or rupture, which may cause fire, electric shock or injury.
	Store the battery fully charged when not in use.	Overheating, ignition, or rupture, causing fire, electric shock, or injury.
	Batteries should be checked and fully charged every three months.	Battery deterioration may occur.

\*Batteries self-discharge even when not in use. Always check and fully charge the battery if left for too long as it may deteriorate!

## 10 Error codes on the LCD display

In the event of any abnormalities, an audible alarm will sound, and an error code will appear on the LCD screen. Please refer to the list of error codes below for details on the codes displayed on the LCD screen and follow the accompanying instructions.

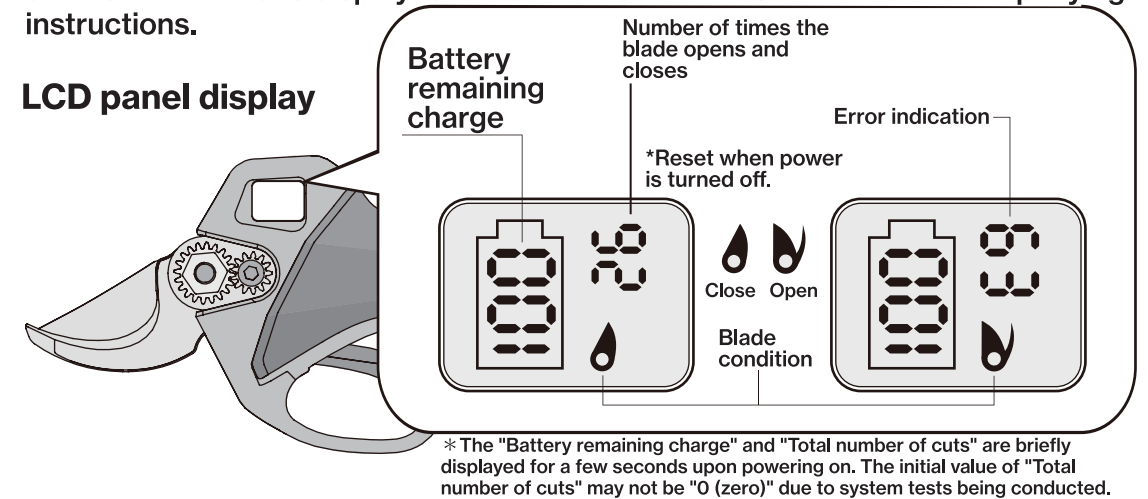

Error code	Description of error	How to resolve
E2	Current Sensor Error	Turn off the power and wait for some time before using it.
E3	Damaged MOS on the motherboard	Turn off the power and wait for some time before using it.
E4	Damaged or severely damaged blades	
E5	SOVercurrent/overvoltage protection resulting in shutdown	Use after a short time with the power off.
E6	Barriers to opening and closing	Avoid obstacles when using the system.
E7	malfunctions	Please contact the store of purchase.
E8	Low voltage and overvoltage errors	Turn off the power and wait for some time before using it.
E9	Elevated motherboard temperature	
E10	Communication error/voltage error	
E11	Memory chip error	Please contact the store of purchase.
E12	Phase detection error	
E13	program error	
E16	Outliers in the internal cell of the battery	Replace the battery.
E17	Poor communication between the motherboard and battery	Please contact the store of purchase.

## 11 FAQ

Symptoms	Possible causes.	How to deal with it	page
Unable to work	Aging batteries or those nearing the end of their useful life.	Replace the battery with a new one when it cannot be recharged. * The battery can be recharged approximately 300 times, but its actual service life depends on usage conditions.	8
	The charger is faulty.	Replace the charger with a new one.	7
	The charger is not properly plugged into the power outlet.	Plug it into an electrical outlet.	7
	Charging outdoors or in unsuitable environments.	Charge the battery indoors at temperatures between 5°C and 45°C * Avoid charging in extremely cold environments.	-
Not functioning	The battery is not charging.	Charge the battery.	7
	The battery is not installed correctly.	Install the battery correctly.	8
	Dust adheres to the contact points (battery terminals) between the battery and the body.	Remove debris.	7
	The power supply was cut off because the heavy load triggered the protective device.	Re-connect the power.	8
Error Code displayed	Check the error code details.	Take appropriate action based on the error code.	18
Short battery life	Batteries are aged or failing.	Replace the battery with a new one.	8
	The battery is dormant.	Charge and discharge the battery several times to remove the dormant state before using it again. *If recovery is not possible, replace the battery with a new one.	8
	Used in low-temperature environments.	This is due to the characteristics of lithium-ion batteries and is not abnormal.	-
Dull blade /Frequent peel residue.	There is resin on the blade.	Clean off grease and astringent.	14
	Blades are worn, chipped, twisted, or deformed (resulting from cutting hard objects).	Replace the blade with a new one.	15 16
	The battery is low.	Charge the battery.	7
	The blades are loose.	Tighten the center nut.	12

If there is still any abnormality after the above inspection,  
**discontinue use immediately.**

Please contact the store of purchase.

## 12 Basic specification

Basic specification	
Item number	EP-720
Total length	286mm
Blade length	52mm
Weight	925g (Includes 1 battery)
Maximum cutting diameter (for live wood)	Up to 25 mm diameter <small>Varies depending on the tree.</small>
Input voltage	DC14.4V
Battery capacity (Li-ion)	2.5Ah
Charging Voltage	AC100V~240V 50/60Hz
Standard charging time	1-2 hours (per battery)
Continuous usage time	3-4 hours (depending on working conditions)

- Other specifications.
- High-carbon steel
  - With LCD screen
  - Forged blade (lower blade only)
  - With holster
  - Hard chrome plated finish
  - Dedicated handheld case
  - Durability-enhancing 3-stage machined blade
  - Replaceable blade type
  - Anti-Slip Polishing

## 13 Optional Accessories

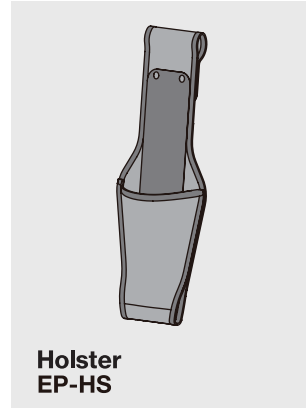
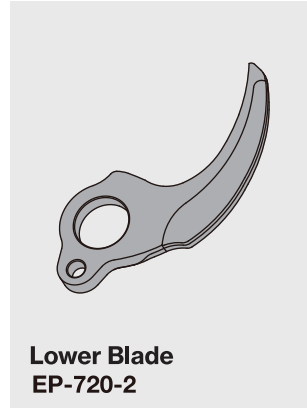
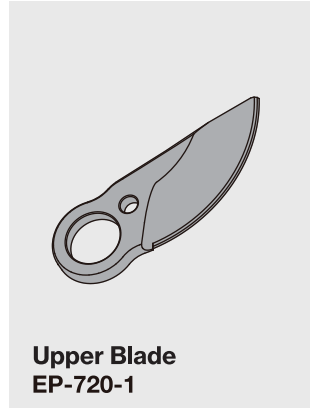

Please refer to the official website for various videos and more detailed information.



## 16 Free Repair Policy

1. We offer free repairs if malfunctions occur within one year from the date of purchase under normal usage conditions as described in the instruction manual or on the product label.
2. Please present the product and this warranty certificate at the time of repair or adjustment, and request service at the original point of purchase.
3. The following conditions will result in paid repairs even within the warranty period:
  - a. Malfunctions or damages caused by improper use or negligence.
  - b. Malfunctions or damages resulting from unauthorized disassembly, repair, or modification.
  - c. Malfunctions or damages due to natural disasters such as fire, pollution, water damage, or earthquakes.
  - d. Changes in appearance occurring during use (scratches on the case, pipe, or other components).
  - e. Malfunctions or damages resulting from use other than the intended purpose of the product.
  - f. Failure to present this certificate, or alterations to its contents.
  - g. Missing purchase date, customer name, or seller information on this certificate.
  - h. Consumable items (upper blade, lower blade, holster, carrying case, battery).
  - i. Malfunctions or damages due to the use of unauthorized power sources (voltage) or similar.
4. Please keep this document safe, as it will not be reissued.
5. In case of paid repairs, customers are responsible for transportation and related expenses. © This warranty assures free repairs within the specified period and conditions stated herein. It does not limit the legal rights of the customer. For inquiries regarding repairs after the warranty period, please contact the original point of purchase if clarification is needed.